

# IKA

designed for scientists

EN

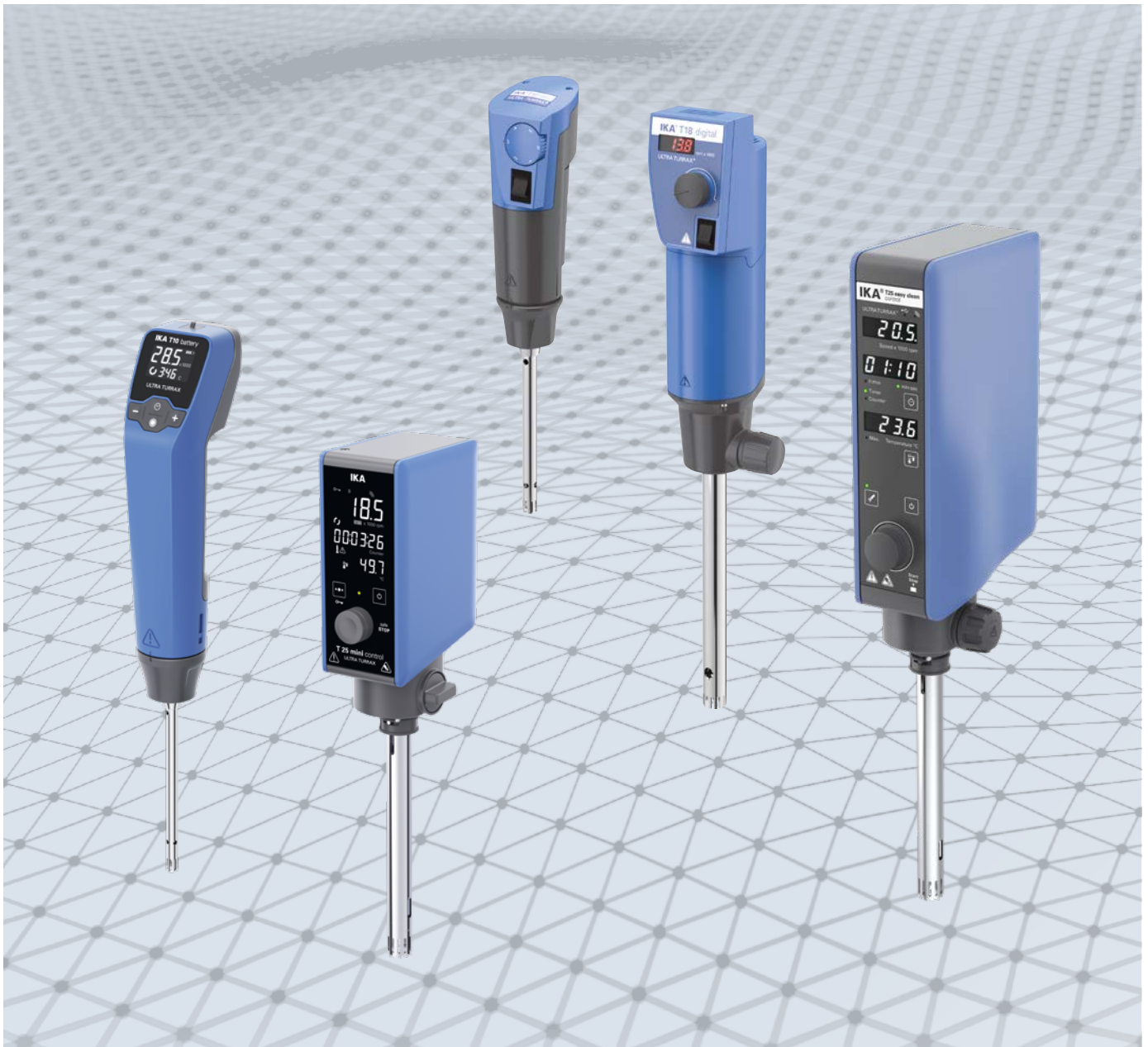

HIGH PERFORMANCE HOMOGENIZING | [Dispersers](#)

## More than 50 years of dispersing expertise

### DISPERSERS

/// Proven and precise technology

ULTRA-TURRAX® - the epitome of first-rate dispersing devices enable the best possible results whether used for homogenization, emulsification or suspensions. The IKA range of dispersers are used for volumes ranging from 0.5 to 50,000 ml (H<sub>2</sub>O) and come equipped with a digital display. These dispersers offer a wide speed range up to 30,000 rpm that enables users to work at high circumferential speeds even with small rotor diameters. The high-performance drive ensures immense speed stability. Due to their broad spectrum of dispersing tools, IKA dispersers are highly effective for a variety of uses.

The unique and patented ULTRA-TURRAX® Tube Drive system is the world's first disperser system with disposable and sealed sample tubes. Multiple tube styles are available for mixing, homogenizing and grinding for a variety of applications.



### Personalized application support

In the IKA Application Center you can test the dispersers yourself. Our experts analyze your processes and work with you to find out how your application can be optimized.

### Worldwide service

To opt for the IKA dispersers is also to opt for the excellent IKA service in your region. Our team is available worldwide for your service and application needs. Availability of spare parts is guaranteed for 10 years.

Do you have any questions? Our service team is at your disposal:  
**+82 (2) 2136 6800**



\*2+1 years after registering at [www.ika.com/register](http://www.ika.com/register), wearing parts excluded

## Dispersers

/// High performance homogenizing

### T-series

IKA's T- and T brushless series are high speed and high shear instruments that are used for dispersing, emulsifying and homogenizing. With the easy clean tools, no disassembling is required for cleaning. The brushless motor guarantees a dust-free and silent operation.

### High performance with minimal footprint

The handheld disperser T 10 battery and our mini dispersers T 18 mini digital and T 25 mini control are our new additions to the IKA ULTRA-TURRAX® family and are designed for precision dispersing, emulsifying and homogenizing, offering high performance in a compact, innovative way.

### UTL 25 in-line system

The in-line system is designed for circulation or flow-through processing in the laboratory. It is sterilizable, autoclave-compatible and suitable for vacuum or pressurized operation (up to 6 bar).

---

4	28
/// T-SERIES	/// ULTRA-TURRAX® TUBE DRIVE
14	29
/// DISPERSING TOOLS	/// SCALE-UP SOLUTIONS
18	30
/// ACCESSORIES	/// INDUSTRIES & APPLICATIONS
19	31
/// UTL 25 IN-LINE SYSTEM	/// FAQ
22	
/// SELECTION GUIDE	

## T-series

/// Innovative solutions for dispersion technology

IKA's T-series of dispersers are designed for mixing and dispersing of products with a wide range of viscosities. This series of dispersers enables the best possible results for any application with improved product quality and better stability.

Handheld operation

T 10 battery  
ULTRA-TURRAX®  
Ident. No. 0020137799



T 25 digital  
ULTRA-TURRAX®  
Ident. No. 003725000



T 18 mini digital  
ULTRA-TURRAX®  
Ident. No. 0020128587

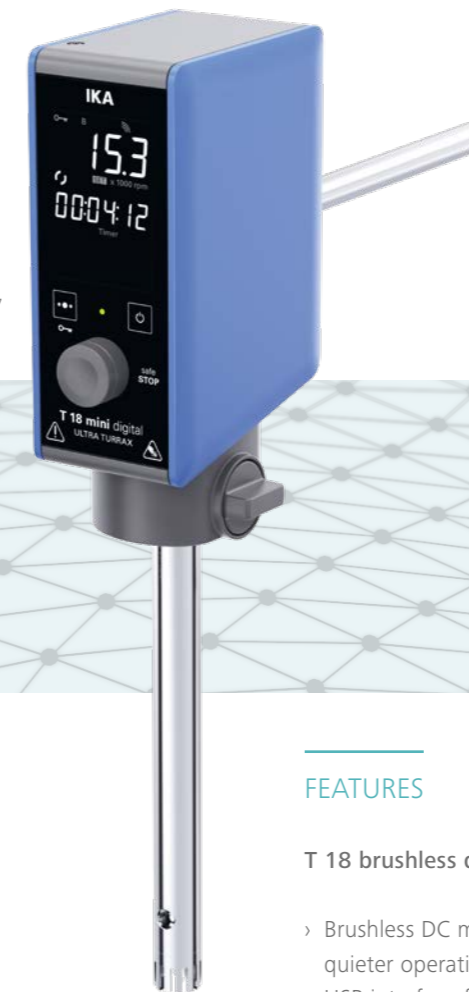

T 18 brushless digital  
ULTRA-TURRAX®  
Ident. No. 0020107460



## Upgraded technology: new brushless motor series

The new generation of the T 18 disperser comes with an upgraded housing design for increased robustness. The dispersing tools can be easily changed to accommodate a wide range of applications and to facilitate easy cleaning of the shafts after use.

### FEATURES

- › Motor protection against overload
- › Quick-connect coupling to exchange dispersing tools easily
- › Digital display for precise monitoring of set and actual speeds
- › Wide selection of dispersing tools to suit your application
- › Rotating knob for adjustment of speed



### FEATURES

#### T 18 brushless digital ULTRA-TURRAX®

- › Brushless DC motor guarantees dust-free and quieter operation
- › USB interface for control and documentation via labworldsoft®
- › Timer function for unattended operation
- › Digital display for indication and adjustment of rotational speed
- › Various dispersing tools available to meet different application needs
- › Electronic overload protection

## Easy Clean series

T 25 easy clean digital  
ULTRA-TURRAX®  
Ident. No. 0025006537



### Electronically commutated motor

IKA applies a new motor technology to the devices in the T 25 easy clean series: the brushless DC motor, with a noise level of 70 dB, ensures a significant noise reduction in the lab. It also allows for carbon dust-free operation.

### Easy cleaning

Easy clean means: The disperser is easily cleaned without disassembly, thanks to its manually extendable rotor, which allows for fast cleaning and rinsing between batches.

### Resistant surface

IKA developed a particularly resistant housing for the new disperser. The timer function for the easy-to-read display is another outstanding feature.



Remote control  
with WiCo

T 25 easy clean control  
ULTRA-TURRAX®  
Ident. No. 0025006540



### Integrated temperature measurement

Yet another highlight is the patented, integrated temperature measurement in the T 25 easy clean control version. The temperature sensor is integrated into the tool and thus enables the real-time monitoring of the medium temperature.

Heat-sensitive samples can also be protected with the safety temperature setting, which helps to avoid overheating and damage to temperature-sensitive samples and any intermediates formed in situ.

### Tool service time

A maintenance reminder can be set to help maintain the dispersing tool in its optimum condition for everyday use.

T 25 mini control  
ULTRA-TURRAX®  
Ident. No. 0020121224

### Automation and documentation

These devices can be connected to the IKA laboratory software labworldsoft® which allows software control and process documentation to meet the most stringent audit standards.

**PATENTED**

The temperature measurement integrated in the disperser is patented. Another patent for the wireless temperature measurement is pending.

## T 10 battery ULTRA-TURRAX®

The IKA T 10 battery is IKA's first battery-operated, cordless homogenizer, specifically designed for handheld laboratory applications. Ideal for small volumes up to 100 ml (H<sub>2</sub>O), this homogenizer can even be operated inside a microcentrifuge tube.



### ADVANTAGES

- › **Cordless and Portable:** Thanks to its battery-operated design, the T 10 battery is perfect for on-site sampling operations. No need for an electricity supply.
- › **Versatile Application:** Ideal as a tissue homogenizer to break down complex tissues. A wide range of dispersing tools are available to suit various application needs, such as blunt-edged, sawtooth, stainless steel, and plastic types.
- › **User-Friendly:** Large TFT display for easy parameter viewing, precise speed setting with numerical values, timer and counter functions for reproducible and precise operation.
- › **Efficient Power Supply:** Rechargeable battery with two charging options: either directly through a USB-C cable or via a charging clamp.

### APPLICATION

- › Perfect for homogenizing small sample volumes in laboratories.
- › Ideal for mobile operations where no electricity supply is available.
- › Efficient in breaking down complex tissue samples.

Versatile use:  
mounted or handheld



## T 18 mini digital & T 25 mini control ULTRA-TURRAX®

Redefine your lab's efficiency and precision with IKA's new mini homogenizers. Compact, powerful, and ready to meet your most demanding requirements.



reddot winner 2024

### ADVANTAGES

#### T 18 mini digital / T 25 mini control

- › **Compact and Space-Saving Design:** up to 40% smaller footprint than comparable models, fits into even the smallest lab spaces.
- › **Cleanroom Ready:** Brushless DC motor ensures dust-free and quiet operation.
- › **Clear TFT Display:** Easy-to-read screen for speed and timer settings.
- › **Smart Connectivity:** Full range of interfaces enables software updates, communication with other instruments and integration with labworldsoft® software for automation and data logging.
- › **Unattended Operation:** Timer and counter functions ensure safe working and reproducible test results.
- › **Perfect for your low-viscosity homogenization tasks:** With its motor power of 160 W, the devices are ideal for any simple homogenizing task up to 1.5 liters and support viscosities up to 2000 mPas.

### ADDITIONAL ADVANTAGES

#### T 25 mini control

- › **Additional Safety for Samples:** The patented temperature sensing function in the dispersing tools monitors medium temperature in real-time. Safety temperature settings protect temperature-sensitive samples from degradation.
- › **Easy to clean and time-saving:** Compatible with "easy-clean" dispersing tools for quick and simple cleaning.

up to 40% smaller  
and much lighter than  
comparable devices



# The optimal disperser for your application

**Scale-up principle**  
 IKA dispersers have a high degree of flexibility and scalability. Therefore, ensuring reliable scale-up by offering the possibility to work with the same method from formulation development to production.



**T 10**  
basic

0.5 – 100 ml  
5000 mPas



**T 65**  
digital

2 – 50 l  
5000 mPas

**1:50**



Further process solutions can be found on [www.ikaprocess.com](http://www.ikaprocess.com)



- |                                      |                                    |   |   |                                      |  |                                      |   |   |                                      |                                      |
|--------------------------------------|------------------------------------|---|---|--------------------------------------|--|--------------------------------------|---|---|--------------------------------------|--------------------------------------|
| <b>T 10 battery</b><br>ULTRA-TURRAX® | <b>T 10 basic</b><br>ULTRA-TURRAX® | <b>T 18 mini digital</b><br>ULTRA-TURRAX® | <b>T 25 mini control</b><br>ULTRA-TURRAX® | <b>T 18 digital</b><br>ULTRA-TURRAX® | <b>T 18 brushless digital</b><br>ULTRA-TURRAX® | <b>T 25 digital</b><br>ULTRA-TURRAX® | <b>T 25 easy clean digital</b><br>ULTRA-TURRAX® | <b>T 25 easy clean control</b><br>ULTRA-TURRAX® | <b>T 50 digital</b><br>ULTRA-TURRAX® | <b>T 65 digital</b><br>ULTRA-TURRAX® |
| Ident. No. 0020137799                | Ident. No. 00037370A0              | Ident. No. 0020128587                     | Ident. No. 0020121224                     | Ident. No. 0003720000                | Ident. No. 0020107460                          | Ident. No. 0003725000                | Ident. No. 0025006537                           | Ident. No. 0025006540                           | Ident. No. 0003787000                | Ident. No. 0004234500                |

→ scale up solutions

Dispersing tools are not included in the scope of delivery.

Dispersing tools are not included in the scope of delivery.

## Technical data

Technical data	T 10 battery ULTRA-TURRAX® Ident. No. 0020137799	T 10 basic ULTRA-TURRAX® Ident. No. 003737000	T 18 mini digital ULTRA-TURRAX® Ident. No. 0020128587	T 18 digital ULTRA-TURRAX® Ident. No. 0003720000	T 18 brushless digital ULTRA-TURRAX® Ident. No. 0020107460
Motor rating input / output	30 / 25 W	125 / 75 W	210 / 160 W	500 / 300 W	400 / 300 W
Volume range (H <sub>2</sub> O)	0.5 – 100 ml	0.5 – 100 ml	1 – 1500 ml	1 – 1500 ml	1 – 1500 ml
Viscosity max.	200 mPas	5000 mPas	2000 mPas	5000 mPas	5000 mPas
Speed range	8000 – 30 000 rpm	8000 – 30 000 rpm	3000 – 25 000 rpm	3000 – 25 000 rpm	3000 – 25 000 rpm
Speed display	LCD	scale	LCD	LED	LED
Speed control	stepless	stepless	stepless	stepless	stepless
Noise without element	65 dB(A)	65 dB(A)	75 dB(A)	75 dB(A)	70 dB(A)
Extension arm diameter	8 mm	8 mm	13 mm	13 mm	13 mm
Extension arm length	100 mm	100 mm	160 mm	160 mm	160 mm
Process type	batch	batch	batch	batch	batch
Dimensions (W x D x H)	51 x 68 x 238 mm	56 x 66 x 178 mm	66 x 100 x 186 mm	87 x 106 x 271 mm	89 x 161 x 270 mm
Weight	0.5 kg	0.61 kg	1.8 kg	2.5 kg	3 kg
Perm. ambient temperature	5 – 40 °C	5 – 40 °C	5 – 40 °C	5 – 40 °C	5 – 40 °C
Permissible relative moisture	80 %	80 %	80 %	80 %	80 %
Protect. class DIN EN 60529	IP 30	IP 30	IP 30	IP 20	IP 30
Interface	yes	no	yes	no	yes
Voltage	12 V	230 V	100 – 240 V	220 – 240 V	220 – 240 V
Frequency	50/60 Hz	50/60 Hz	50/60 Hz	50/60 Hz	50/60 Hz

Technical data	T 25 mini control ULTRA-TURRAX® Ident. No. 0020121224	T 25 digital ULTRA-TURRAX® Ident. No. 0003725000	T 25 easy clean digital   control ULTRA-TURRAX® Ident. No. 0025006537   0025006540	T 50 digital ULTRA-TURRAX® Ident. No. 0003787000	T 65 digital ULTRA-TURRAX® Ident. No. 004234500
Motor rating input / output	210 / 160 W	800 / 500 W	500 / 400 W	1100 / 700 W	2600 / 2200 W
Volume range (H <sub>2</sub> O)	1 – 1500 ml	1 – 2000 ml	1 – 2000 ml	0.25 – 30 l	2 – 50 l
Viscosity max.	2000 mPas	5000 mPas	5000 mPas	5000 mPas	5000 mPas
Speed range	600 – 25 000 rpm	3000 – 25 000 rpm	3000 – 25 000 rpm	600 – 10 000 rpm	1000 – 9500 rpm
Speed display	LCD	LED	LED	LED	LED
Speed control	stepless	stepless	stepless	stepless	stepless
Noise without element	75 dB(A)	75 dB(A)	70 dB(A)	72 dB(A)	75 dB(A)
Extension arm diameter	13 mm	13 mm	13 mm	16 mm	flange
Extension arm length	160 mm	160 mm	160 mm	220 mm	flange
Process type	batch	batch	batch	batch	batch
Dimensions (W x D x H)	66 x 100 x 186 mm	87 x 106 x 271 mm	89 x 161 x 270 mm	115 x 139 x 355 mm	300 x 400 x 420 mm
Weight	1.8 kg	2.5 kg	3 kg	5.85 kg	35 kg
Perm. ambient temperature	5 – 40 °C	5 – 40 °C	5 – 40 °C	5 – 40 °C	5 – 40 °C
Permissible relative moisture	80 %	80 %	80 %	80 %	80 %
Protect. class DIN EN 60529	IP 30	IP 20	IP 30	IP 20	IP 54
Interface	yes	no	yes	no	no
Voltage	100 - 240	220 – 240 V	220 – 240 V	220 – 240 V	3 x 400 V
Frequency	50/60 Hz	50/60 Hz	50/60 Hz	50/60 Hz	50/60 Hz

## Dispersing tools

IKA dispersing technology works by using the rotor-stator principle. The system consists of a rotor within a stationary stator. Due to the high circumferential speed, the medium to be processed is drawn axially into the dispersion head and then forced radially through the slots in the rotor-stator arrangement. The high speed and minimal gap between the rotor and stator produces extremely strong shear forces which results in better dispersion within a very short time frame.

A wide variety of rotor-stator configurations and seals are required to process different mediums. In order to make the device adaptable to the user's specific needs, it is sometimes necessary to use two dispersing tools to achieve from coarse to fine particle size reduction. The quick-connect coupling facilitates the exchange of dispersing tools.

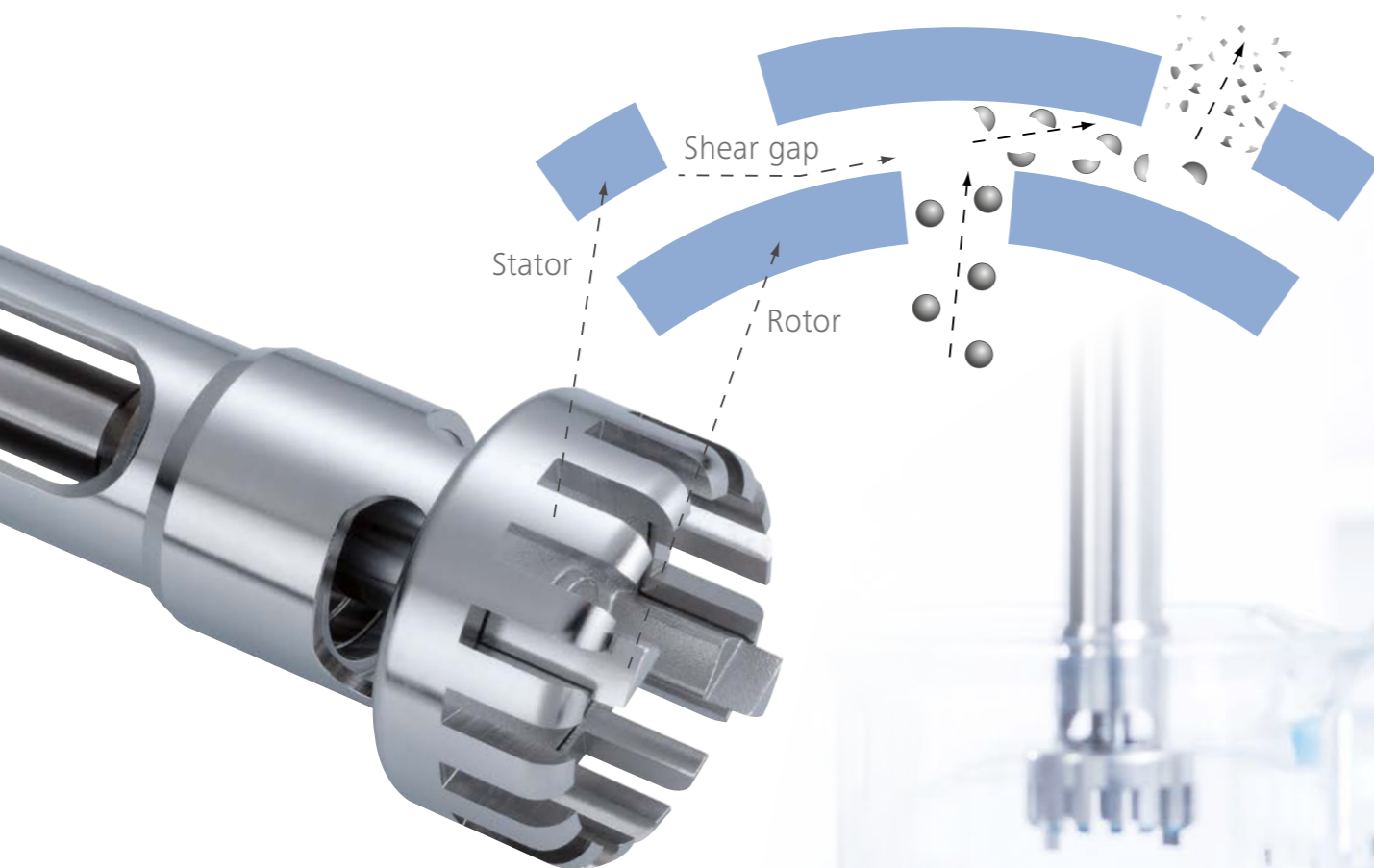

### Nomenclature Dispersing elements

For dispersing instrument	Dispersing element shaft / agitator shaft	Seal or bearing type*	Generator or element**	Outer diameter (mm)	Degree of fineness achieved***
T 10 basic	S 10	N	–	5 / 8 / 10	G
T 18 digital / T 18 brushless digital	S 18	N	–	10 / 19	G
T 25 digital	S 25	N / KV / KD / C	–	8 / 10 / 18 / 19 / 25	G / F
T 25 easy clean digital / control	S 25 / S 25 EC	N / KV / KD / C / EC	–	18 / 25	G / F
T 50 digital	S / R 50	N / KG-HH / KD	G / W	45 / 65 / 80	G / M / F
T 65 digital	S 65	KG – HH / KD / C	G	65	G / M / F

C = Ceramic-coated stainless steel

\*N = PTFE bearing

KV = Ball bearing with vacuum-tight sliding-ring seal and silicon carbide seal rings

KD = Ball bearing with PTFE sealing and FFKM O-ring

KG – HH = Ball bearing with hard metal sliding-ring seal and FFKM seal rings

\*\*G = Proved configuration

W = Special element

\*\*\*G = Coarse

M = Medium

F = Fine

All parts in contact with the product are made of FDA-compliant materials.

Dispersing element	Volume range (ml)	Vacuum operation	Vacuum (mbar)	Circumferential speed (m/s)	Ultimate fineness, suspensions (µm)	Ultimate fineness, emulsions (µm)
S 10 N - 5 G	0.5 – 10	No	-	6	5 – 25	1 – 10
S 10 N - 8 G	1 – 50	No	-	9.6	5 – 25	1 – 10
S 10 N - 10 G	1 – 100	No	-	11.9	5 – 25	1 – 10
A S 10 N - 8 G - ST	1 – 50	No	-	9.6	5 – 25	1 – 10
S 10 N - 10 G - ST	1 – 100	No	-	11.8	5 – 25	1 – 10
S 10 D - 7 G - KS - 65	1 – 20	No	-	7.5	10 – 50	5 – 20
S 10 D - 7 G - KS - 110	1 – 40	No	-	7.5	10 – 50	5 – 20
S 18 N - 10 G	1 – 100	No	-	9.8	10 – 50	1 – 10
B S 18 N - 19 G	10 – 1500	No	-	16.6	10 – 50	1 – 10
S 18 D - 10 G - KS	10 – 100	No	-	8.5	10 – 50	5 – 20
S 18 D - 14 G - KS	10 – 500	No	-	12.0	10 – 50	5 – 20
S 25 N - 8 G	1 – 50	No	-	8	10 – 50	1 – 10
S 25 N - 10 G	1 – 100	No	-	9.8	10 – 50	1 – 10
S 25 N - 18 G	10 – 1500	No	-	16.6	10 – 50	1 – 10
S 25 N - 25 G	50 – 2000	No	-	22.3	15 – 50	1 – 10
S 25 N - 25 F	100 – 2000	No	-	23.6	5 – 25	1 – 5
S 25 N - 8 G - ST	1 – 50	No	-	8	10 – 50	1 – 10
S 25 N - 10 G - ST	1 – 100	No	-	9.8	10 – 50	1 – 10
S 25 N - 18 G - ST	10 – 1500	No	-	17.5	10 – 50	1 – 10
S 25 N - 25 G - ST	50 – 2000	No	-	26.2	10 – 50	1 – 10
C S 25 KV - 18 G	10 – 1500	Yes	1	16.6	10 – 50	1 – 10
S 25 KV - 25 G	50 – 2000	Yes	1	22.2	15 – 50	1 – 10
S 25 KV - 25 F	100 – 2000	Yes	1	23.6	5 – 25	1 – 5
D S 25 KV 2802	10 – 1500	yes	1	39.3		
S 25 KD - 18 G	10 – 1500	Yes	100	16.6	10 – 50	1 – 10
S 25 KD - 25 G	50 – 2000	Yes	100	22.2	15 – 50	1 – 10
S 25 KD - 18 G - ST	10 – 1500	Yes	100	17.5	10 – 50	1 – 10
S 25 KD - 25 G - ST	50 – 2000	Yes	100	26.2	10 – 50	1 – 10
S 25 KD - 25 F	100 – 2000	Yes	100	23.6	5 – 25	1 – 5
S 25 KD - LR - 25 G	50 – 2000	Yes	100	9.6	5 – 25	1 – 10
S 25 KD - LR - 25 F	100 – 2000	Yes	100	11.8	5 – 25	1 – 10
S 25 KD - LR - 30 G	50 – 5000	Yes	100	28.8	15 – 50	1 – 10
S 25 KD - LR - 30 F	100 – 5000	Yes	100	30.1	5 – 25	1 – 5
S 25 D - 10 G - KS	10 – 100	No	-	8.5	10 – 50	5 – 20
S 25 D - 14 G - KS	10 – 500	No	-	12	10 – 50	5 – 20
S 25 EC - C - 18 G	10 – 1500	No	-	16.6	10 – 50	1 – 10
S 25 EC - C - 25 G	50 – 2000	No	-	22.2	15 – 50	1 – 10
S 25 EC - C - 25 F	100 – 2000	No	-	23.6	5 – 25	1 – 5
S 25 EC - C - 18 G - ST	10 – 1500	No	-	17.5	10 – 50	1 – 10
S 25 EC - C - 25 G - ST	50 – 2000	No	-	26.2	10 – 50	1 – 10
D S 25 EC - T - C - 18 G	10 – 1500	No	-	16.6	10 – 50	1 – 10
S 25 EC - T - C - 25 G	50 – 2000	No	-	22.2	15 – 50	1 – 10
S 25 EC - T - C - 18 G - ST	10 – 1500	No	-	17.5	10 – 50	1 – 10
S 25 EC - T - C - 25 G - ST	50 – 2000	No	-	26.2	10 – 50	1 – 10
S 25 EC - T - C - 25 F	100 – 2000	No	-	23.6	5 – 25	1 – 5

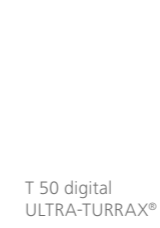

Dispersing element	Volume range (ml)	Vacuum operation	Vacuum (mbar)	Circumferential speed (m/s)	Ultimate fineness, suspensions (µm)	Ultimate fineness, emulsions (µm)
S 50 N - G 45 G	500 – 20000	No	-	18.8	40 – 100	10 – 30
S 50 N - G 45 G - ST	500 – 20000	No	-	19.9	40 – 100	10 – 30
S 50 N - G 45 M	500 – 15000	No	-	21.2	25 – 50	5 – 20
S 50 N - G 45 F	250 – 10000	No	-	20.9	10 – 30	1 – 10
S 50 KG - HH - G 45 G	500 – 20000	Yes	1	18.8	40 – 100	10 – 30
S 50 KG - HH - G 45 G - ST	500 – 20000	Yes	1	18.8	40 – 100	10 – 30
S 50 KG - HH - G 45 M	500 – 15000	Yes	1	21.2	25 – 50	5 – 20
E S 50 KG - HH - G 45 F	250 – 10000	Yes	1	20.9	10 – 30	1 – 10
S 50 KD - G 45 G	500 – 20000	Yes	100	18.8	40 – 100	10 – 100
S 50 KD - G 45 G - ST	500 – 20000	Yes	100	19.9	40 – 100	10 – 100
S 50 KD - G 45 M	500 – 15000	Yes	100	21.2	25 – 50	5 – 20
S 50 KD - G 45 F	250 – 10000	Yes	100	20.9	10 – 30	1 – 10
R 50	250 – 30000	No	-	23.6		
S 50 N - W 65 SK	100 – 10000	No	-	28.8	50 – 200	5 – 15
S 50 N - W 80 SMK	100 – 50000	No	-	17.8		
R 1405	250 – 30000	-	-	-	-	-
R 1402	100 – 30000	-	-	-	-	-
S 65 C - G 65 G	2000 – 50000	No	-	26.4	25 – 75	5 – 25
S 65 C - G 65 M	2000 – 40000	No	-	28.8	20 – 50	5 – 15
S 65 C - G 65 F	2000 – 30000	No	-	28.8	5 – 20	1 – 10
S 65 KG - HH - G 65 G	2000 – 50000	Yes	1	26.4	25 – 75	5 – 25
F S 65 KG - HH - G 65 M	2000 – 40000	Yes	1	28.8	20 – 50	5 – 15
S 65 KG - HH - G 65 F	2000 – 30000	Yes	1	28.8	5 – 20	1 – 10
S 65 KD - G 65 G	2000 – 50000	Yes	100	26.4	25 – 75	5 – 25
S 65 KD - G 65 M	2000 – 40000	Yes	100	28.8	20 – 50	5 – 15
S 65 KD - G 65 F	2000 – 30000	Yes	100	28.8	5 – 20	1 – 10
D 60	2000 – 30000	No	-	9.6	5 – 25	1 – 10
D 80	2000 – 50000	No	-	17.5	10 – 50	1 – 10

\* IKA recommendations only

## Other accessories



### S 18/25 - ET50 Disposable tube

For attaching plastic tools from S 18 D and S 25 D series. Allows for dispersing under enclosed conditions.

Ident. No. 0003452500



### Silentstream

The flow breaker is used to prevent vortexing and to minimize air induction into the medium.

Fits the following dispersing elements:  
All S 25 / S 25 EC shafts with a diameter of 18 – 25 mm

Ident. No. 0003754000



### TS 25-3 Cleaning tool

Cleaning tool for cleaning three dispersing elements. The cleaning tool consists of an aluminum stand, three cleaning tubes (PP) and three covers with openings (PP).

Fits the following dispersing elements:  
All S 25 shafts with a diameter of 18 – 25 mm

Ident. No. 0020003013



### CT.15 Cleaning tube

Cleaning tube for cleaning the S 25 dispersing tools used in combination with the T 25 digital and T 25 easy clean digital / control.

Ident. No. 0020006595



### HS 25 EC - DW Holder

Holder for S 25 easy clean dispersing tools to use in a dishwasher.

Ident. No. 0025007380



### WiCo T 25 easy clean control

The wireless controller (WiCo) allows to operate and monitor the T 25 easy clean control disperser e.g. in a fume hood and therefore helps protecting the user from toxic material exposure.

WiCo is only compatible with the T 25 easy clean control disperser. The WH 11 wall mount and two USB cables are included in the scope of delivery.

Ident. No. 0025006310

## UTL 25 in-line system

/// For circulation or flow-through processing in the laboratory

### FEATURES

- › Simple, compact and sturdy modular design
- › Sterilizable, autoclave-compatible
- › Table-top or stand-supported device, low space requirement
- › Easy disassembly
- › Large delivery capacity of 4.4 to 11.6 l/min with open outlet (the mounting of a valve can reduce the flow rate)
- › For air-free, sterile, and inline suspension, emulsifying and deagglomeration
- › For vacuum or pressurized operation (up to 6 bar)
- › If the DK 25.11 is used, air induction is also prevented in batch operation
- › Not self-priming
- › A pump can be integrated between intake nozzle and vessel. As a result, viscous fluids can be processed
- › The hoses used should have an inner diameter size of 13 mm (inlet) and 9 mm (outlet) respectively to fit the DK 25.11 flow chamber



UTL 25 digital Inline  
ULTRA-TURRAX®

Ident. No. 0010006868

## Technical data

Technical data	UTL 25 digital InLine ULTRA-TURRAX® Ident. No. 0010006868
Motor rating input	500 W
Motor rating output	300 W
Pump rate	11.6 l/min
Speed range	3000 – 25 000 rpm
Speed adjustment	stepless
Speed display	scale
Noise without element	73 dB(A)
Extension arm diameter	13 mm
Extension arm length	175 mm
Chamber volume	26 ml
Attainable vacuum	1 mbar
Pressure max.	6 bar
Process type	inline
Dimensions (W x H x D)	450 x 120 x 100 mm
Weight	3.8 kg
Permissible ambient temperature	5 – 40 °C
Permissible relative humidity	80 %
Protection class according to DIN EN 60529	IP 20
Voltage	230 V
Frequency	50/60 Hz
Power input	500 W

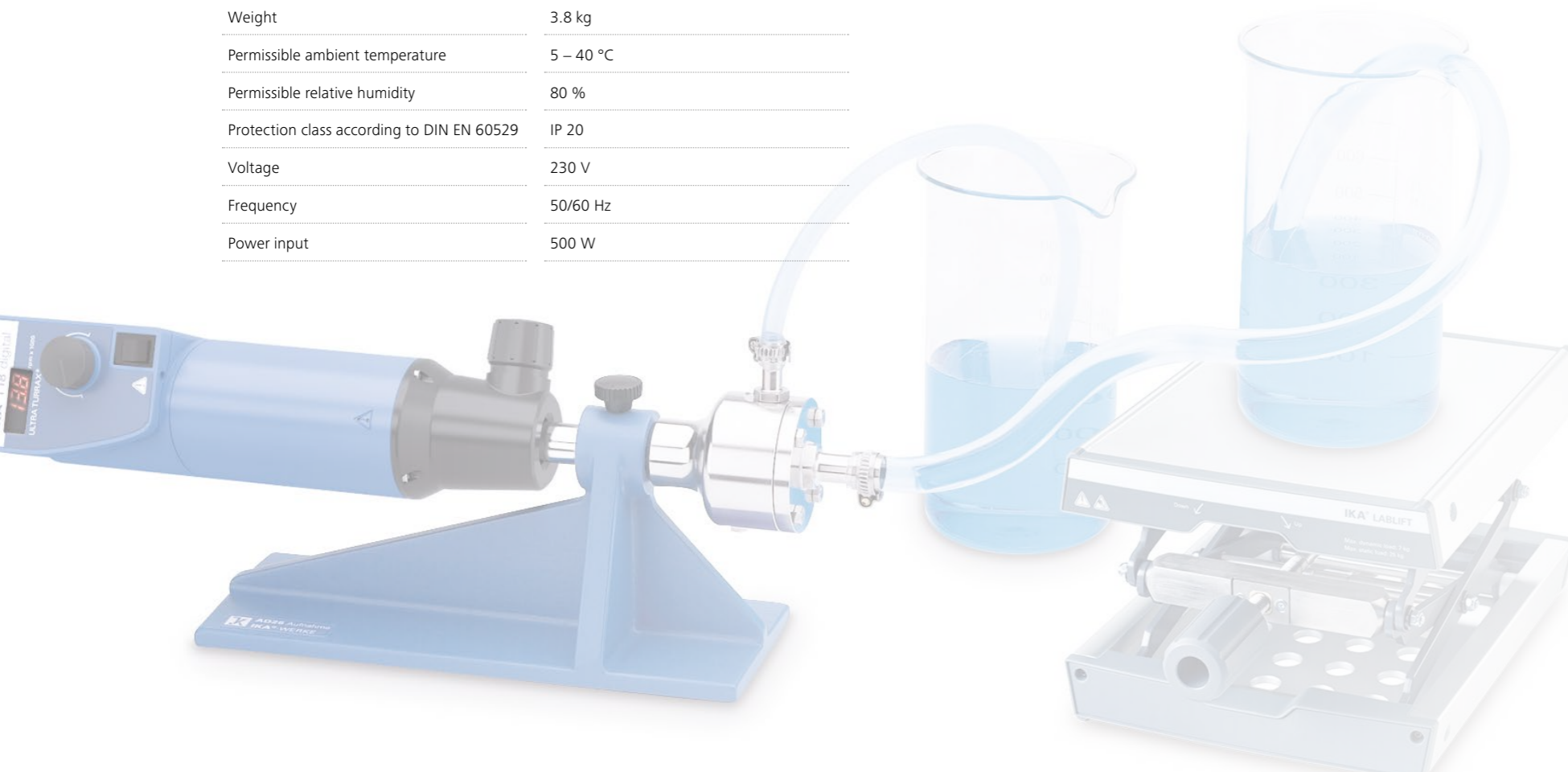

## Dispersing elements for UTL 25 digital InLine ULTRA-TURRAX®

Dispersing element	S 25 KV - 25 G - IL	S 25 KV - 25 F - IL
Ident. No.	0002563000	0002830200
Stator diameter	25 mm	25 mm
Rotor diameter	17 mm	18 mm
Gap between rotor and stator	0.5 mm	0.5 mm
Circumferential speed max.	22.2 m/s	23.6 m/s
Immersion depth	40 – 85 mm	40 – 85 mm
Shaft length	110 mm	110 mm
Material in contact with medium	FFPM / SIC, AISI 316L	FFPM / SIC, AISI 316L
pH range	2 – 13	2 – 13
Suitable for solvents	yes	yes
Working temperature max.	220 °C	220 °C
Sterilization methods	all methods	all methods

## Other accessories



**AD 25 Mounting support**  
Mounting support for flow chamber  
DK 25.11  
Ident. No. 0002562500



**DK 25.11 Flow chamber**  
For S 25 KV - 25 ... - IL dispersing elements.  
Batch operation:  
DK 25.11 is mounted around the dispersing element. The DK 25.11 must be at a lower elevation than the surface of the liquid during operation. With this operating mode, no air is drawn in as a result of turbulence in the vessel.

The hoses used should have an inner diameter of 13 mm (inlet) and 9 mm (outlet) to fit the flow chamber.  
Ident. No. 0002518000

## Selection Guide IKA Dispersers

/// Proven and precise dispersion technology  
for your application



Model	T 10 battery ULTRA-TURRAX®	T 10 basic ULTRA-TURRAX®	T 18 mini digital ULTRA-TURRAX®	T 25 mini control ULTRA-TURRAX®	T 18 digital ULTRA-TURRAX®	T 18 brushless digital ULTRA-TURRAX®	T 25 digital ULTRA-TURRAX®	T 25 easy clean digital ULTRA-TURRAX®	T 25 easy clean control ULTRA-TURRAX®	T 50 digital ULTRA-TURRAX®	T 65 digital ULTRA-TURRAX®
Motor type	Brushless DC, battery-powered	Carbon brush	Brushless DC	Brushless DC	Carbon brush	Brushless DC	Carbon brush	Brushless DC	Brushless DC	Brushed motor	brushless AC
Motor rating input / output	30 W / 25 W	125 W / 75 W	210 W / 160 W	210 W / 160 W	500 W / 300 W	400 W / 300 W	800 W / 500 W	500 W / 400 W	500 W / 400 W	1100 W / 700 W	2600 W / 2200 W
Speed range	8000 – 30 000 rpm	8000 – 30 000 rpm	3000 – 25 000 rpm	600 – 25 000 rpm	3000 – 25 000 rpm	3000 – 25 000 rpm	3000 – 25 000 rpm	3000 – 25 000 rpm	3000 – 25 000 rpm	600 – 10 000 rpm	1000 – 9500 rpm
Max. circumferential speed	11.9 m/s	11.9 m/s	16.6 m/s	16.6 m/s	16.6 m/s	16.6 m/s	30.1 m/s	30.1 m/s	30.1 m/s	28.8 m/s	28.8 m/s
Theoretical volume range (H <sub>2</sub> O)	0.5 ml – 100 ml	0.5 ml – 100 ml	1 ml – 1.5 l	1 ml – 1.5 l	1 ml – 1.5 l	1 ml – 1.5 l	1 ml – 2 l	1 ml – 2 l	1 ml – 2 l	250 ml – 30 l	2 – 50 l
Recommended volume range	100 ml and under	100 ml and under	100 ml – 500 ml	100 ml – 500 ml	200 ml – 1.5 l	200 ml – 1.5 l	200 ml – 2 l	200 ml – 2 l	200 ml – 2 l	2 l – 30 l	10 l – 50 l
Recommended maximum viscosity	200 mPas	5000 mPas	2000 mPas	2000 mPas	5000 mPas	5000 mPas	5000 mPas	5000 mPas	5000 mPas	5000 mPas	5000 mPas
Operation type	Handheld or Benchtop	Handheld or Benchtop	Benchtop	Benchtop	Benchtop	Benchtop	Benchtop	Benchtop	Benchtop	Benchtop	Floor standing
Timer function	√	–	√	√	–	√	–	√	√	–	–
Recommended vessels	Microcentrifuge tubes, Falcon tubes	Microcentrifuge tubes, Falcon tubes	Conical flasks, beakers	Conical flasks, beakers	Conical flasks, beakers	Conical flasks, beakers	Conical flasks, beakers, closed reactor systems	Conical flasks, beakers, closed reactor systems	Conical flasks, beakers, closed reactor systems	Beakers, stainless steel mixing vessels	Floor mixing vessels (stainless steel)
Automation ready	√	–	√	√	–	√	–	√	√	–	–
Temperature sensing	–	–	–	√	–	–	–	–	√	–	–
Interface	USB-C	–	USB-C	USB-C, WPAN, Wifi, Ethernet	–	Micro-USB	–	Micro-USB	Micro-USB	–	–
Dimensions (W × D × H)	51 × 68 × 238 mm	56 × 66 × 178 mm	66 × 100 × 186 mm	66 × 100 × 186 mm	87 × 106 × 271 mm	89 × 161 × 270 mm	87 × 106 × 271 mm	89 × 161 × 270 mm	89 × 161 × 270 mm	115 × 139 × 355 mm	300 × 400 × 420 mm

## Selection Guide Dispersing tool

/// How to choose the right dispersing tool



### Shaft Nomenclature

#### Compatible Dispersing Motor:

- › S 10: T 10 basic
- › S 18: T 18 digital / mini
- › S 25: T 25 digital / mini
- › S 25 EC: T 25 easy clean
- › S 50: T 50 digital
- › S 65: T 65 basic / digital

#### Shaft Working Conditions / Sealing Systems:

- › **N or C:** dispersing in open containers under ambient conditions
- › **KV or KG – HH:** dispersing under positive pressure and vacuum conditions as low as 2 mbar
- › **KD:** dispersing under no positive pressure and for vacuum conditions up to 100 mbar

#### Diameter and Working Volume:

- › **Number:** stator diameter, determines the mixing volume

#### Ultimate sample fineness achievable:

- › **G / M / F:** coarse / medium / fine ultimate sample particle size

#### Special Tool Design:

- › **ST:** sawtooth design for sample precutting in solution (e.g. fibrous samples)
- › **KS:** plastic dispersing tools

### Shaft Selection Criteria

#### Volume

Shafts with larger stator diameters can support bigger volumes. Always check the technical datasheet of each tool to know the working volume range that each size can process.

Vessel opening sizes should also be verified to ensure the dispersing tool fits inside the mixing vessel.



S 18 N - 10 G



S 25 N - 25 G

#### Final particle size

The teeth gap determines the final particle size that can be achieved.

G: coarse tool (general purpose)  
M: medium tool  
F: fine tooth



S 25 KD - 25 G



S 25 N - 25 F

#### Sample property / hardness

Hard samples like plastic resins are best processed with blunt-edged rotor-stator systems. These are general purpose use dispersers that can also be used for making emulsions and dissolving powders.

Fibrous samples like meat, leaves and paper can be processed more effectively using sawtooth, jagged edged rotor-stator systems.



S 25 N - 25 G ST



S 25 KD - 25 G

#### Open or closed system operation

Dispersing tools come with different sealing systems to support either open or closed system applications.

**N/C:** for open batch applications e.g. in beakers  
**KD:** for closed system applications under vacuum (min: 100 mbar)  
**KV/KG-HH:** for closed system applications under vacuum and/or positive pressure (min: 2 mbar)

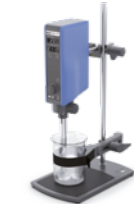

T 25 easy clean digital



LR 2 ST

#### Temperature sensitive samples

Specialised dispersing tools come with a patented integrated temperature sensor to measure the actual medium temperature in real time and safety temperatures can be set to protect heat-sensitive samples from degradation or overheating.

Choose the EC-T-C dispersing tools with the appropriate motor.



S 25 EC - T - C - 25 G

#### Materials in contact with medium

For standard applications in the food, cosmetic, chemical and pharmaceutical industries, stainless steel and plastic materials are compatible with most samples.

In biological and life science laboratories, plastic may be the material of choice if stainless steel is incompatible with certain samples or to avoid cross-contamination.



S 18 D - 10 G - KS



S 25 N - 25 G

#### Autoclave compatible

All N/C dispersing tools are made of materials that can withstand autoclaving conditions.

For all other tools, care needs to be taken as some bearings are unable to withstand autoclaving conditions.



S 25 EC - T - C - 25 G



S 25 N - 25 G



## Accessories



(A)

**R 182 Boss head clamp**  
Ident. No. 0002657700



(B)

**R 1825 Plate stand**  
Height: 560 mm  
With slip resistant mat  
Ident. No. 0003160000

**R 1826 Plate stand**  
Height: 800 mm  
With slip resistant mat  
Ident. No. 0003160100

**R 1827 Plate stand**  
Height: 1000 mm  
With slip resistant mat  
Ident. No. 0003160200



(C)

Dispersing tools in different sizes  
and designs available



(D)

**RH 3 Strap clamp**  
For securing vessels against walls or for  
synchronized rotation during dispersing  
Ident. No. 0003008600

Find more  
accessories on  
[www.ika.com](http://www.ika.com)

### Trial devices

You may request demo units  
in order to experience  
our high-quality disperser  
offerings first hand.

Contact us [here](#)



## OUR SOLUTION AGAINST CROSS-CONTAMINATION

### ULTRA-TURRAX® Tube Drive

/// Ideal for easier, faster, simpler and safer sample preparation

The World's first universal disposable disperser system with hermetically sealable sample tubes:  
 The ULTRA-TURRAX® Tube Drive disperser system provides protection and security for infectious sample materials, toxic and high-odor substances under defined conditions (time, energy, volume).  
 Test procedures are easily duplicated with no cross-contamination between samples. The sample containers (tubes) are easily attached to the drive unit. Desired speed and duration are set, then the test is started. An acoustic signal indicates completion of the experiment.

#### FEATURES

- › Simple and safe disposal
- › Sealed disposable sample tubes
- › No cross-contamination
- › No cleaning required
- › Reproducible tests supports GLP and GMP reporting
- › Chemical resistant plastic
- › Patented
- › Sterile and double sterile (IVD) tube version available
- › Available with pierceable lids
- › Batch traceability ensured

Patented!



ULTRA-TURRAX® Tube Drive  
 P control  
 Ident. No. 0025005981



Watch the product video



All tubes are also available with a pierceable membrane and gamma-sterilized.

## SCALE-UP SOLUTIONS

/// Your next step into production

When transitioning your formulation from laboratory to production, reliable pilot products are crucial for success. However, maintaining consistent results during the scale-up process can be challenging. Reproducibility becomes a genuine concern. This is where IKA steps in.

IKA offers a one-stop, smooth transition of formulations and technologies from laboratory to large-scale production. Results acquired in the laboratory, translate from process and recipe development to production scale in a consistently reliable manner.



To explore IKA's cutting-edge process technology solutions,

Visit [www.ikaprocess.com](http://www.ikaprocess.com)



## INDUSTRIES & APPLICATIONS

### FOOD

food paste  
fruit juice concentrate  
orange peel  
vegetables  
cheese  
pork meat  
salami  
spices  
peanuts

### CHEMISTRY

oil  
fuel oil  
crude oil  
waste water  
calcium carbonate  
polymer solution  
dishwasher tabs  
surfactant  
manganese dioxide

### BUILDING MATERIAL

ceramic glaze  
wood  
clay powder  
loam  
glass fiber  
engobe powder  
bentonite  
wall paint  
iron mica

### ENVIRONMENT

soil samples  
compost  
algae  
roots  
resin  
disposal waste  
biogas mud  
plant leaves  
animal excrements

### MEDICINE & PHARMACY

medicine analeptic  
capsules  
tablets  
acetate  
muscle tissue  
collagen granules  
pills  
beta carotene  
calcium phosphate

### COSMETICS

ointments  
baby cream  
body lotion  
collagen  
flavors  
carnival make-up  
day cream  
showering gel  
shaving gel



## FAQ

1. What does "continuous operation" mean for dispersers? Are 4 hours OK?

4 hours equate to continuous operation. A further particle size reduction with rotor-stator systems does not happen after more than 15 min. Only heat (due to friction) is transferred into the medium. For the drive itself, continuous operation is not a problem.

2. Due to the technical data, the ambient temperature of a disperser is 5 – 40 °C. What can be done, if the sample requires higher temperatures?

The prescribed ambient temperature of 5 – 40 °C is only valid for the drive. Of course, it is possible to work in mediums with higher temperatures, e.g. a dispersing element with PTFE Bearing (N) can be used in mediums up to 180 °C.

3. Is it possible to disperse abrasive materials such as sand, glass or similar material?

In general, it is possible to disperse abrasive material, but a frequent change of the bearing is necessary. In addition, the shaft and spindle can wear off very quickly under these conditions.

4. Is it possible to disperse frozen samples?

Yes, in general this is possible if the sample is processed in liquid. However, it is not possible to work with liquid nitrogen.

5. The teflon seal (PTFE) of my dispersing element is ripped. Can a new one be ordered?

Those PTFE parts are slotted and it is not a defect. They are used as a bearing. If necessary, a new seal may be ordered from the spare parts list.

6. How often can the disposable dispersing elements for the T 10 basic, T 18 digital and T 25 digital be used?

The disposable dispersing tools are designed for single use only.

7. Does IKA offer high pressure dispersers?

Yes, it is possible to work under a pressure of up to 6 bar with dispersing tools having "KV" in their product description. IKA also offers high pressure homogenizer systems with our process division.

8. How can foam formation during dispersion be avoided?

To avoid this scenario, a ULTRA-TURRAX® disperser with KV, KD or KG-HH tools is recommended. These tools are closed systems, which avoid the generation of foam.

9. The ULTRA-TURRAX® dispersing elements should not run dry. Does that mean that the bottom bore hole has to be in the medium?

Yes, the circulation hole should be in the medium on all accounts. This is the only way to guarantee the optimum cooling effect on the internal bearing to prolong its longevity.

10. Which is the right dispersing tool to crush vegetables and fruits? How should one clean this properly (sterile)?

The Saw Tooth (ST) dispersing tools and a T 50 digital with cutting head S 50 N - W 65 SK are suitable for this application. The tools can be cleaned e.g. with acetone or every commonly used sterilization method.





designed for scientists

# Everything for your Lab

IKA is your reliable partner in laboratory, analysis and process technology. When it comes to applications in the areas of stirring, mixing, tempering, distilling or grinding, market leaders rely on our proven products and technology. We are continually working to further develop our portfolio according to the needs of our customers. Building on this, we network our products and services to create holistic, application-oriented solutions and enable our customers to achieve the best possible results and step into the digital age.



BIOREACTORS



MIXING



HEATING / COOLING /  
TEMPERING



LIQUID HANDLING



MEASURING VISCOSITY



VACUUM TECHNOLOGY



CRUSHING



LABORATORY SOFTWARE



SEPARATION



ELECTROCHEMISTRY



REACTOR SYSTEMS



CALORIMETRY

## IKA Korea Ltd.

8F S03, Chungmin-ro 10,  
Song pa-gu 05840 Seoul, Korea  
+82 (2) 2136 6800 / sales-lab@ika.kr



IKAworlwide// #lookattheblue



Stay up to date:  
[www.ika.com/](http://www.ika.com/)  
newsletter

Technical specifications are subject to  
change without notice.  
Information on delivery not binding